



## QUALIDISC PRO/QUALIDISC FARMER

SHORT DISC HARROWS

# WHEN FARMING MEANS BUSINESS

Realising the full potential of farming is about growing and developing your business, not only your crop or livestock, but also your profit. Improve productivity and profitability by focusing on the positives and minimising disadvantageous aspects, through strong, dedicated management.

Success springs from determination and clear targets, from laying down the appropriate strategy and allocating correct investments for the future. Quality results require the right ideas and equipment. When there is work to be done, you need the optimal setup and smart solutions that support you towards an easier, more profitable way of working. You need solutions that make tough and demanding conditions less complicated.





## TILLAGE

Preparing and cultivating your soil in order to achieve the highest possible yield is about choosing the correct tillage system.



2 YEARS WARRANTY

# YOUR KVERNELAND

## INTELLIGENT FARMING SOLUTIONS



Choose the best farming solution for you and your land. Combine the highest possible yields with sustainability. This will start with the correct tillage. The choices you make depend on various factors and should match your specific circumstances, like soil structure, crop rotation, residue management, economic and ecological viabilities.

*The choice is yours!*

You must consider environmental and legal issues. From conventional methods to conservation tillage: the balance of operations at the right time has to be found to achieve high yields with the best soil condition (air, moisture, biological activity, etc.) with a minimum amount of energy, time and investment. For this, Kverneland offers a full range of intelligent farming solutions.



Kverneland Group is a leading international company developing, producing and distributing agricultural machinery and services.

Strong focus on innovation allows us to provide a unique and broad product range with high quality. Kverneland Group offers an extensive package aimed at the professional farming community, covering the areas of soil preparation, seeding, forage and bale equipment, spreading, spraying and electronic solutions for agricultural tractors and machinery.

# SMART FARMING

## CONVENTIONAL AND CONSERVATION TILLAGE

### CONVENTIONAL TILLAGE

#### Conventional Tillage

- **Intensive** method of cultivation.
- Complete soil inversion e.g. by a plough.
- Less than 15-30% crop residues left on soil surface.
- Seedbed preparation done by an active tool or special seedbed harrow.
- High phytosanitary effect by reduced pressure of weed and fungi diseases - fewer herbicides and fungicides needed.
- Better dry-off and faster increase of soil temperature for better nutrients absorption.

### CONSERVATION TILLAGE

#### Mulch Tillage























- **Reduced** intensively in terms of depth and frequency.
- More than 30% of residues are left on soil surface
- Extended repose period of the soil.
- Cultivator and/or discs incorporate the crop residues within the top 10cm of soil for stable bearing soil.
- Full-width tillage - seedbed preparation and seeding in one pass.
- Protection against soil erosion; reduce soil loss by run-off and improve water storage capacity.
- Improvement of soil moisture retention

#### Strip Tillage

- **Zonal strip loosening** before or during seeding of up to 1/3 of the row width (Loibl, 2006). Up to 70% of the soil surface remains untouched.
- Strip-till combines the soil drying and warming benefits of conventional tillage with the soil-protecting advantages of no-till by disturbing only the area of the soil where the seeds are placed.
- Exact fertilising deposit.
- Soil protection against erosion and drought.

#### Vertical Tillage / No-Till

- **Extensive** method.
- Working soil vertically avoids additional horizontal layers or density changes.
- Increasing water infiltration, root development and nutrient take-up.
- Plants' roots dictate the overall health of the plant, as they deliver nutrients and water throughout, contributing to a higher yield.
- A strong set of roots make plants more resistant to wind and drought
- Lower energy input required

KVERNELAND'S INTELLIGENT FARMING SOLUTION			Method	Deep Tillage (not a must)	Basic Tillage	Seedbed Preparation	Seeding	Spreading	Spraying
CROP ESTABLISHMENT SYSTEMS	CONSERVATION	extensive	Vertical Tillage shallow tillage						
		> 30% Soil coverage after Seeding	Strip Tillage stripwise loosening						
	CONVENTIONAL	intensive	Mulch Seeding without soil inversion						
		15 - 30% Soil coverage after Seeding	Reduced Till without soil inversion						
		up to 15% Conventional with soil inversion							

CLASSIFICATION OF TILLAGE METHODS KVERNELAND (Source: adapted from KTBL)



SPEED

DURABILITY

VERSATILITY

EFFICIENCY





## HIGH CAPACITY AND PERFORMANCE

### SPEED UP WHEN THE TIME IS RIGHT

#### **Speed**

After harvest, you want to get ready for the next crop establishment immediately. Tomorrow conditions may be worse, so speed is important. You need a machine that has the right capacity to finish the job on time, to relieve your time pressure.

#### **Versatility**

Conditions are not the same in field, you want to be flexible. Adjust to shallow and deeper cultivation with excellent penetration and cutting quality. Stubbling, seedbed preparation alike. Versatile machines like the Qualidisc ensure cost savings.

#### **Durability**

You want a machine that lasts, that copes with the stress on the frame and discs over a long time. That's why Kverneland has developed the Qualidisc with heavy-duty maintenance-free bearings and special heat treatment for the discs. Heavy-duty and maintenance-free mean strong durability.

#### **Efficiency**

You invest in the best equipment for cultivation. In return you want the best results and low cost of operation. The Kverneland range of Qualidisc is developed with an optimised weight. Less lifting and pulling force needed means saving on fuel.

*Incorporate straw, promote germination and reduce volunteer seeds.*

## CULTIVATION AND SEEDBED PREPARATION FAST OPERATIONS

Powerful and efficient performance - that is what the Qualidisc offers. The machine can operate at high forward speeds of 18 to 20km/h whilst maintaining constant cutting of the whole field at a consistent working depth to have the same seedbed everywhere.

*Up to 20km/h for high performance.*

With the Qualidisc range, Kverneland provides two versions of short disc harrows which are the right choice for high performance soil preparation, all kinds of conditions and for a wide field of applications. In fact, the Qualidisc range is dedicated to the following jobs:

- Opening the soil after frost or winter rainfalls, enhancing the air flow for quicker warming up
- Seedbed preparation in front of spring seeding, for example maize crops that need deeper cultivation for a good root development
- Stubble cultivation right after harvest
- Second or third pass to destroy weeds and volunteers saving herbicide
- Cutting of maize stubbles to prevent corn borer
- Preparing the soil for a fine crumbled seedbed able to enhance germination even for fine seeds like rape, grass etc.



Up to 20km/h

For high performance.

0

Maintenance-free bearings.

20%

Special heat treatment for longer lifetime

2 YEARS

Warranty on Qualidisc.

## SHORT DISC HARROW



## CULTIVATION FROM DEEP TO SHALLOW FULL RANGE AVAILABLE

The Qualidisc is the machine on the farm for establishing and making cultivation from 2cm to 15cm. Kverneland proposes different configurations depending of the conditions of use and also the power ability:

**Qualidisc Farmer:** rigid models from 2.00m to 4.00m - up to 200hp  
fold models from 4.00 to 6.00m - up to 300hp  
trailed models from 4.00 to 6.00m - up to 300hp

**Qualidisc Pro:** rigid models from 2.50 to 4.00m - up to 240hp  
fold models from 4.00 to 6.00m - up to 350hp  
trailed models from 4.00 to 7.00m - up to 400hp

The **Qualidisc Pro** is for shallow as well as for deeper cultivation up to 15cm. It shows excellent performance with large amounts of residues (straw, intermediate green crops, etc.) thanks to its 600mm diameter discs. The Qualidisc Pro convinces with good penetration, deeper cultivation and superb cutting quality in combination with high output, simple adjustments and minimum maintenance costs. The Qualidisc Pro is extremely sturdy as it is fitted with a frame of the well-established quality Kverneland cultivator range.

The **Qualidisc Farmer** is a lighter version of the Qualidisc Pro for more shallow use. This machine is for farmers who want to use the short disc harrow up to 10cm deep. Consequently, the machine is 15% lighter on mounted version and 7% on trailed version, easier to lift, ideal for reducing soil compaction and energy saving as it is lighter to pull.

- Complete cutting
- Perfect mixing & levelling
- Low pulling force needed
- Wide range of rollers
- Reduced maintenance
- Versatile from shallow to medium
- Large performance by high speed
- Stone protection

## 3 STEPS FOR EFFECTIVE CULTIVATION THE QUALIDISC CONCEPT

On farms the Qualidisc offers excellent performance at high speed. The range of operations is versatile (2-15cm) from shallow and deep stubble cultivation, seedbed preparation after ploughing as well as for incorporation of catch crops due to the large conical discs and the high inter-row distance of 900mm. With the Qualidisc, you optimise the use of tractor horse power and maximise the performance at lower costs.

*High quality soil cultivation.*

1

### **Tillage**

The Kverneland Qualidisc Pro (600mm) and Qualidisc Farmer (520mm) offer two rows of discs. Each conical disc is heat-treated and mounted with elastic rubber buffers. The high inter-row distance of 900mm ensures optimal soil flow and preparation. On ploughed land a clod board can be mounted on trailed Qualidisc models to adjust the machines to different conditions and tasks.

2

### **Levelling**

The Kverneland short disc harrows offer lateral side deflectors as standard and an optional integrated finger harrow to regulate the soil flow and to achieve a perfect levelling.

3

### **Recompacting**

The third step of perfect seedbed preparation is soil recompaction. Therefore, a wide range of rollers is available to meet the various conditions and requirements.



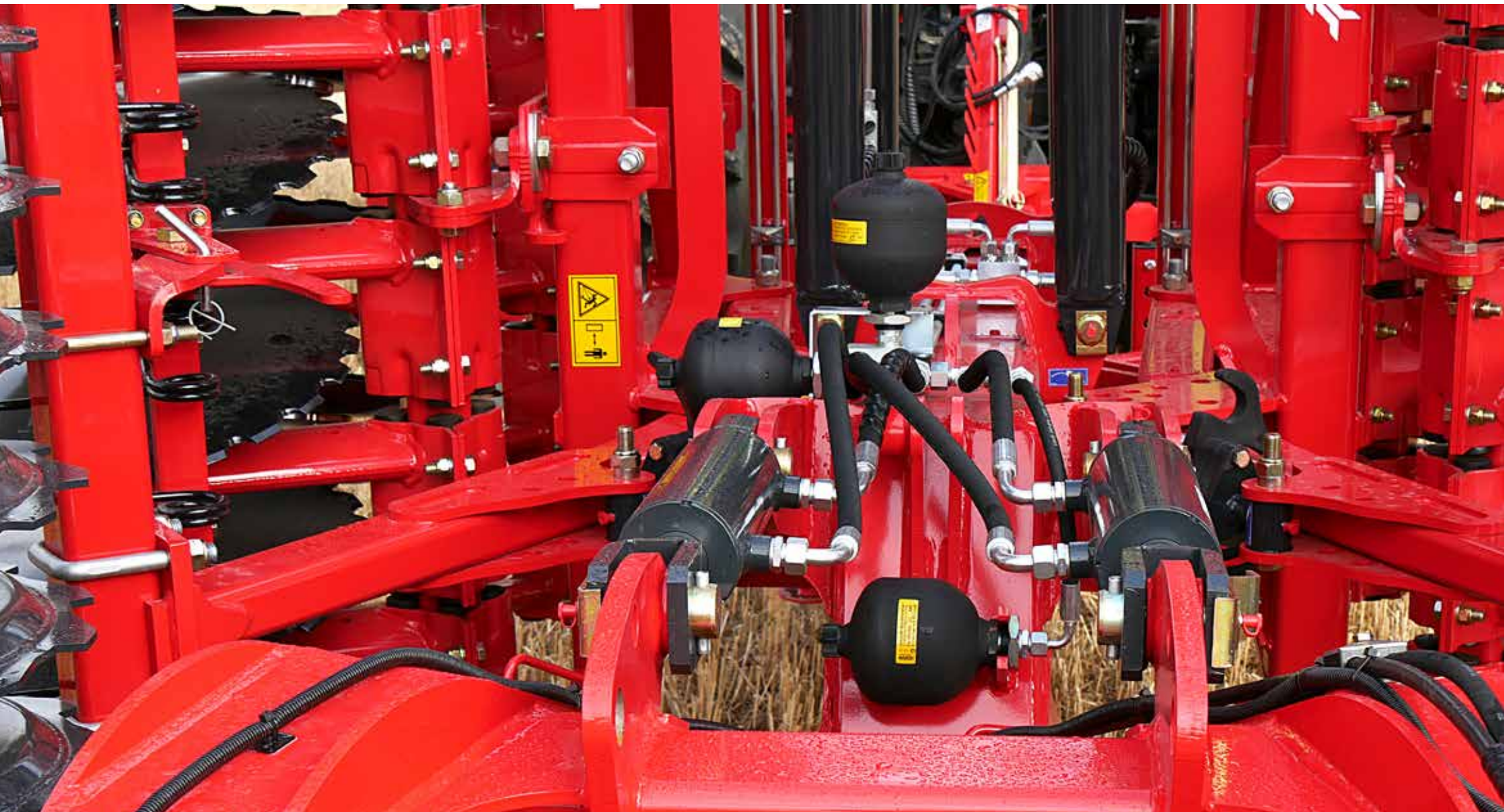





- Strength
- Long lifetime
- Reliable design
- Proven performance

## STRENGTH AND DURABILITY ADVANCED TESTING PROGRAM

Before the Qualidisc Farmer or Qualidisc Pro were launched into the market, they had passed a whole series of tests to ensure the impeccable quality of the product.

- Sophisticated technologies are used for each development such as static load test, finite elements method (FEM) and shake-lifetime tests.
- Finally the machines are tested in the field under different conditions to reconfirm that the requirements to all functions and strength are met. A strict list of requirements (LOR) is defined to meet all kinds of soil conditions.

### *Proven Reliability.*

The frame is a result of a long study made by **FEM (Finite Element Method)** calculation to optimise the steel over the working width and proposing a strong structure able to resist to tractors up to 400hp for the trailed model, up to 250hp for the fold version and up to 240hp for the rigid frame.

The complete Qualidisc range has been designed to be combined with the Actipack roller, which is the heaviest roller in the range. All the most aggressive scenarios (deep working when turning, headland turns, transport tests, etc.) have been considered to make the different frames as strong as possible and thus guaranteeing the proven Kverneland quality.

The trailed Qualidisc models are extremely stable as they are equipped with a **double suspension device** that protects the frame from stress and tremendously increases the stability of the machine during work. Thus bouncing is prevented.

# CONSTANT CUTTING DEPTH WITH FLAT BOTTOM PROFILE

The Qualidisc can be distinguished by a unique feature: it has a flat bottom profile even at shallow depth thanks to the well-studied disc angles and the high speed capacity.

*Perfect bottom profile at shallow depth.*

## Lateral adjustment (only on Qualidisc Pro models)

In order to maintain a good cutting quality, the disc rows of the Qualidisc Pro can be adjusted to each other because the size of the discs is important. This ensures that the short disc harrow always cuts the soil over the entire working width and the wear of the disc can be compensated. A scale indicates the adjustment value according to the disc diameter - simple and efficient. Qualidisc Farmer models can be adjusted in two positions due to their rotating disc gangs.

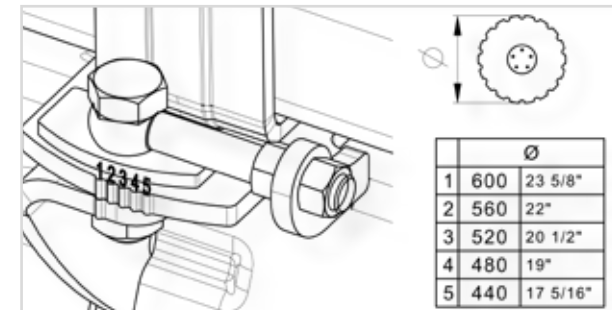
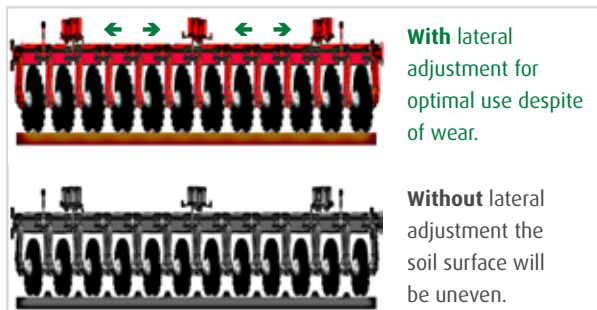



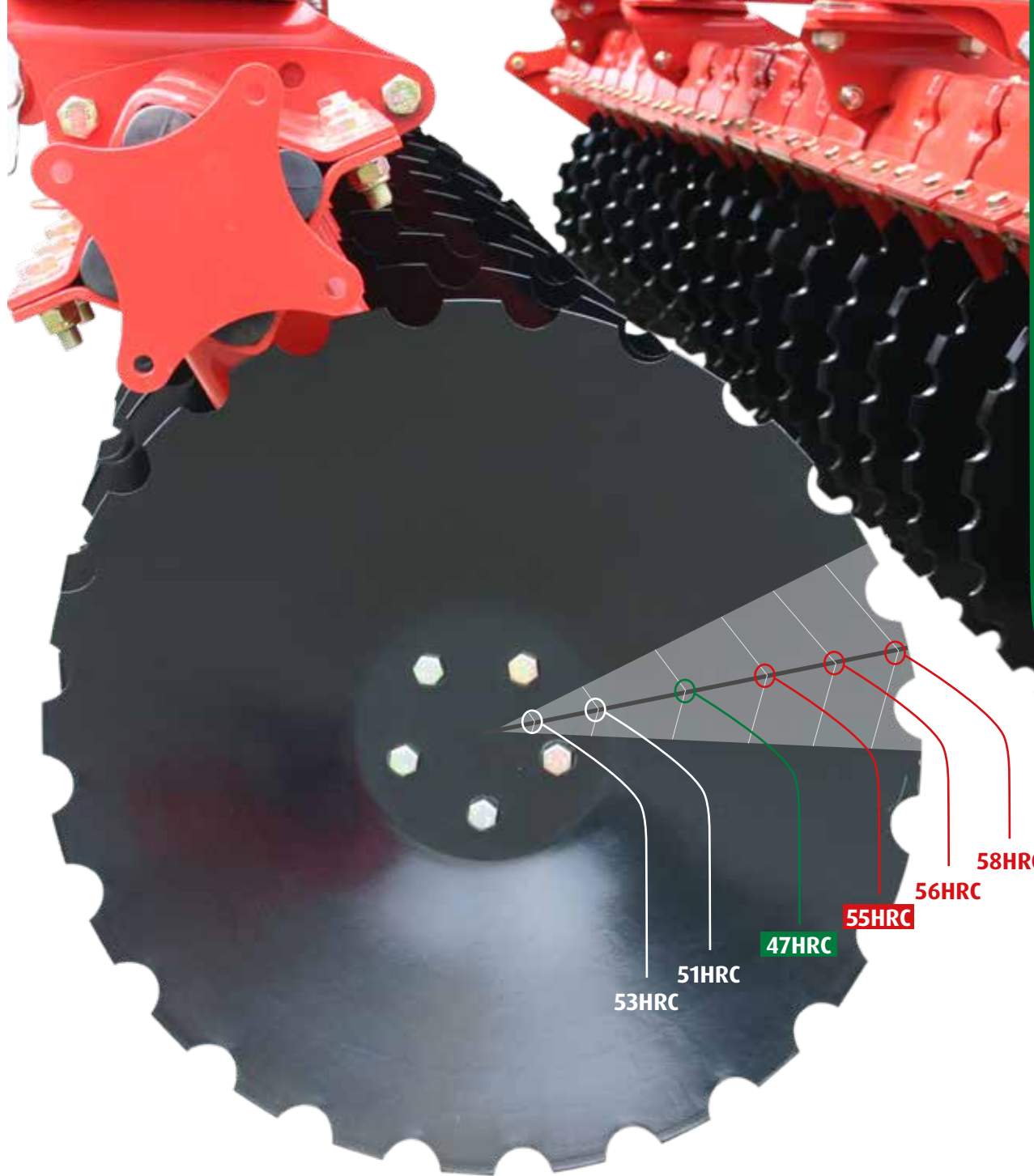

- Special heat treated disc of 55-58HRC (215 kg/mm<sup>2</sup>) for long durability
- Long lifetime. A Kverneland disc is one of the hardest disc in the market!
- Softer center for flexibility against obstacles
- Always optimal soil results due to lateral adjustment despite of wear

# IMPECCABLE CUTTING QUALITY

## EXCELLENT PENETRATION

### Conical notched discs

Due to the **conical design** of the disc, the attack angle is always fixed and the cutting angle always stays in the same position. Curved discs transport more soil and improve the mixing effect.

*20% longer lifetime than a standard disc.*

The discs of the first row ensure good penetration and prevent blockages. The second disc row is working offset and takes over the soil flow and plant residues of the first row.

**Notched discs** work more aggressively, the penetration and self-rotation is improved e.g. ploughing up of grassland or for maize operations. Kverneland also offers a disc with big notches to enhance the rotation and self-cleaning especially in fluffy and sticky soil with more than 20% of clay. Small notches are kept to maintain the very good cutting quality.





- **Constant cutting angle**
- **Perfect ground following**
- **High cutting quality over entire working depth**
- **Constant cutting depth**
- **Overload protection**
- **Optimal soil flow with larger volume of plant residues**

# HIGH QUALITY WITH LONG LASTING COMPONENTS

## Light but strong disc arm

Each disc is protected by a rubber shock system. If the disc hits an obstacle, the disc arm is able to move and the safety system works as a 3D auto-reset system. The profile of the arm prevents sideways movement in cutting position and ensures optimal penetration, even in stony and heavy soils. The cutting angle of the disc always stays in the same position. The special angled disc arm consists of an ellipse profile (Qualidisc Pro) which protects from wearing and the bearing of the soil flow.

*2 years warranty on all Qualidisc models*

## Maintenance-free bearings

Each disc is mounted individually and follows the ground contour perfectly. The maintenance-free double ball bearings are exclusively developed for extreme soil conditions. The bearing has an O-ring on the disc side and 5 sealing lips on the opposite side. These protect against dust and water and minimising wear. The strong 35mm axle is able to carry heavy radial and axial loads. The bearing is fixed with screws and special washers to prevent from loosening. The bolt inside the arm is protected against soil.









SHORT DISC HARROW



## USER COMFORT IS KEY

### EASY ADJUSTMENT

Kverneland always focuses on safe operation and user comfort. With all the adjustments being done without the need for tools, a lot of precious time is saved!

Adjusting the Qualidisc is easily done. The depth is adjusted by hydraulic cylinders (optional mechanically on mounted models) and spacers; and the finger harrow by pin. In addition, there is hardly any maintenance to be done on the Qualidisc apart from changing wearing parts.

*No maintenance, best comfort.*

#### Depth control

Short disc harrows need speed. But with high speed and the conical disc shape there is a risk of floating and not maintaining constant working depth. The depth control of the Kverneland Qualidisc Farmer and Qualidisc Pro is adjusted via the roller equipment. The weight is transferred to the discs due to a locking bush or special lock valve on the hydraulic version. The working depth can easily be adjusted by pivoting spacers, no matter if it is manually (only on mounted models) or hydraulically adjusted. The heavy weight of the roller improves the penetration and caters for a constant working depth.



## THE NEED FOR CONSOLIDATION FIRM SEEDBED

Rollers have been designed to ensure an efficient soil compaction and levelling either after harvest for an optimum germination of weeds or to reduce the soil porosity and limit evaporation in dry conditions.

The choice of the right roller depends on the soil type and conditions. Also the lifting capacity of the tractor needs to be considered when looking for the right combination.

### *Cracking performance.*

**The roller on a short disc harrow is an elementary tool with different tasks:**

- Supporting the exact working depth of the machine especially in light conditions
- Optimal soil to seed/root contact to enable efficient nutrient transfer
- Breaking of clods in order to have a fine seedbed but at the same time keeping the soil structure for reduced soil erosion, as the soil is both structured and stable.
- Improved drainage and water infiltration, especially important in wet years where a good, consolidated soil structure ensures access to plant root systems for water, air and nutrients
- No separation or raising of straw and residues. Minimal moisture loss, especially important in dry years where crops which lack moisture suffer badly
- Reliable working without stick of the soil surface by slipping. Easy maintenance and cleaning.



Work done with an Actipack/  
Actiring roller: left side skids  
lifted up (not active), right side  
skids down in action.



## RECOMPACTION

### ROLLERS FOR ALL TYPE OF SOIL



#### **Actipack Ø 560mm - 205kg/m**

- The Actipack roller displays its superb working qualities especially on medium to heavy soils and also in wet, stony and sticky conditions thanks to the independent skids and knives.
- The cutting discs break the larger clods whilst the adjustable knives cut the remaining clods resulting in optimal clod breakdown and fine seedbed preparation.



#### **Actiring ø 540mm - 160kg/m**

- The Actiring roller is a lighter variant of the Actipack, using the same frame structure and knife system.
- The discs have been replaced by a “V” profile ring, saving 60kg/m, which is of critical importance for reducing lifting requirement for mounted equipment.
- Actiring is not recommended in stony conditions.



#### **Actiflex ø 580mm - 160kg/m**

- The Actiflex roller has been made to create an intensive mixing with all types of conditions, even stony ones.
- The rings are made with spring steel to have a high resistance against stress at high speed.
- Actiflex rings are separated by skids to prevent any accumulation inside the roller.
- This roller is the ideal tool to create a nice seedbed and to enhance the weeds regrowth after harvesting.



### Actipress Twin ø560mm - 220kg/m

- U-profile for high carrying /rolling capacity in light soils
- Clod breaking also in heavy conditions
- Possibility to make different soil profiles by locking the rocking (even or corrugated)
- Self-cleaning effect thanks to the twin u-ring concept
- High stability thanks to the oscillating frame
- High and homogenous re-compaction
- Also suitable for stony conditions
- Weight/m when full of soil : 250 kg/m



### Cage roller ø 550mm - 90kg/m

- 10 bars for a good loading capacity and operation in wet conditions
- Effective crumbling action



### Double cage roller ø 400mm (tube/flat) - 160kg/m

- Good crumbling and levelling effect
- Precise depth control
- High carrying capacity

- **Operator-friendly due to maintenance-free bearings**
- **Protection against dust and water with 5 sealing lips**
- **Extended lifetime: Protection of bearings with an additional steel cover in heavier conditions like stones, twine, mud etc.**





# STUBBLING AND SEEDING IN ONE PASS

## INTEGRATED SEEDER FOR COVER CROPS

The EU nitrate directive aims to protect water resources classed as vulnerable with 50mg nitrate/l. One of the measures considered to avoid nitrate leaching in the water source is the systematic coverage of soils by a vegetal cover in autumn. This cover will absorb nitrogen from the soil and air, and converts it into organic nitrogen compounds. The cover will then release nitrogen to the next crop (1/3), hereby improving soil structure and protecting it from erosion.

a-drill 200 (200l) used for rather small seed rate and a-drill 500 (500l) preferred with higher seed rate (25 to 50kg/ha - mix of seeds, grass, etc.) have been designed to meet a rapid implementation of cover crop during stubble operations while minimising costs. In addition, the a-drill can also be used for establishing rape seed or mixtures of different diameters seeds (leguminous plant, cruciferous, etc.).

The a-drill 200 & 500l can be equipped with two types of fan: electric recommended for small seeds and allowing seed rates of 4 kg/min or hydraulic for rates up to 14 kg/min.

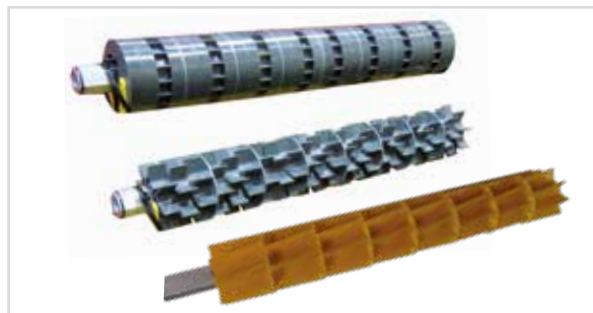

## SAFE ON THE ROAD EASY TO CONVERT



Easy conversion from working to transport position. The two-part hydraulic folding gives a transport width of max. 2.75m. The hydraulic suspension ensures smooth running and safe road transport.

The trailed Qualidisc models are homologated\* at 40km/h in Germany and 25km/h in France. The EU homologation is in progress for a release in January 2018.

\* see local road regulations.

### Tackling blackgrass head-on

With blackgrass becoming more difficult to control, Bradley Farm at Cumnor near Oxford, has opted for the Qualidisc Farmer to create stale seedbeds between harvest and autumn drilling. "As a high-speed shallow cultivator to encourage a flush of weeds, the Qualidisc is a really useful piece of kit," says operator Martin Rockall, who runs the 950-acre farming operation for his employer, the Bowden family. "The Qualidisc really does encourage a lot of growth."

Growing winter wheat, spring barley, maize, grass, stubble turnips and mustard – the latter as a cover crop – the farm operates a mix of min-till and rotational ploughing. And winter ploughing suits spring-sown cereals and maize.

"Our soils range from sand to heavy clay, so we need to make full use of different cultivations systems combined with sprays, to stay on top of grass weed control across the farm," he says.

*Martin Rockall, UK*

950 acres,

Crops: winter wheat, spring barley, maize, grass, stubble turnips and mustard.



**"If time allows between, I'll make two passes with the Qualidisc then spray ahead of the drill," he adds. "But there's only me doing fieldwork at Bradley Farm, so I have to choose kit that is going to be productive and efficient."**

"There is space between the discs to deal with any amount of trash and stubble. It sets up the seedbeds really well for cereal drilling, for which I use a 4.0m Kverneland s-drill and NG-S power harrow combination. And I also have a 6.0m ts-drill for stubble turnips,

mustard and grass seed," he adds.

Supplied by Lister Wilder, the 4.0m hydraulically folding Qualidisc affords good output from a high forward speed, while encouraging a flush of volunteers and weeds, post-harvest. Yet the cultivator is equally as competent at deeper work, ahead of maize drilling, as Martin explains. "We plough through winter, ahead of maize, to let the weather help us on heavier soils," he says. "And then I'll run the Qualidisc through but at a much deeper setting ahead of the maize drill. This loosens the soil nicely, while leaving a firm finish on top for the drill."

## ORIGINAL PARTS & SERVICE

# ONLY ORIGINAL PARTS WILL KEEP YOUR MACHINE A KVERNELAND



Did you know that Kverneland parts are manufactured to the same high standards and strict specifications as Kverneland machines? Original Parts will always work and fit as intended, and are guaranteed to keep your machine running at maximum performance.

Kverneland has been a symbol of quality since 1879; the experience we have, combined with a constant strive to improve our products, ensures that the best parts are available for your Kverneland machine. Parts and service surround your machine with a safety-net. The quality of the machine ensures optimal usage and the quality of the parts provide a low life-cycle cost and longer wearing time.

Our long term relationship starts at the purchase of your Kverneland machine, and we will continuously stay by your side for support and assistance. We will guide you on the way to make sure you achieve maximum performance, productivity and profit.

Do not compromise quality with cheap solutions, remember that only Original Kverneland parts are the guaranteed solution to achieve what is expected by a Kverneland machine.



### YOUR PARTS SPECIALIST

Through our worldwide dealer network you will find your local dealer, whom is always prepared to assist you. Your Kverneland dealer knows every inch of your machine and will gladly provide the expertise needed to ensure that you are operating at maximum potential.

Your parts specialist has got all the parts that you need and will also have the facilities to service your machine. Make sure to visit your Kverneland dealer on a regular basis to be updated on promotions and product news that you will not find elsewhere.



### ALWAYS AVAILABLE

Time is money, and we know the importance of receiving the right parts at the right time! Your Kverneland dealer is supported by a massive distribution network to supply you with exactly what you need, when you need it.

Our main distribution centre is located in Metz, France. A strategic location for distributing parts to all corners of the world. With over 70.000 parts in stock and 24/7 service, we are ready to supply you with parts – at any time!



### EASY ACCESS TO INFORMATION

Are you looking for a complete overview of parts for your machine? Maybe you are searching for more technical information? Our Online Search Database, *Quest*, provides all information available for your machine.

Various documentation like Parts Manuals, Operation Manuals, Software updates and FAQ's are all there. *Quest* is available in several different languages and can be accessed wherever and whenever. All answers are easy to find – just a few clicks away !

# TECHNICAL DATA

Frame	Qualidisc Farmer												Qualidisc Pro												
	mounted rigid				mounted fold				trailed				mounted rigid				mounted fold				trailed				
Working width (m)	2.0	2.5	3.0	3.5	4.0	4.0	5.0	6.0	4.0	5.0	6.0	2.5	3.0	3.5	4.0	4.0	5.0	6.0	4.0	5.0	6.0	7.0			
Transport width (m)	2.0	2.5	3.0	3.5	4.0	2.45				2.5				2.5	3.0	3.5	4.0	2.55				2.75			
Number of discs	16	20	24	28	32	32	40	48	32	40	48	20	24	28	32	32	40	48	32	40	48	56			
Disc diameter - Hardness	520x5 mm - 215kg/mm <sup>2</sup>												600x6 mm - 215kg/mm <sup>2</sup>												
Inter-row distance (mm)	900												900												
Disc spacing (mm)	245				250				250				245				250				250				
Working depth (cm)	2-10				2-10				2-10				3-15				3-15				3-15				
Linkage	Cat. II and Cat. III				Cat. III				Cross shaft Cat. III or Cat. IV N, pivoting or fixe eye Ø50mm**				Cat. II and Cat. III				Cat. III				Cross shaft Cat. III or Cat. IV N, pivoting or fixe eye Ø50mm**				
Underbeam clearance (mm)	794												794												
Depth adjustment	Hydraulic or mechanic by spacer						Hydraulic by spacer						Hydraulic or mechanic by spacer						Hydraulic by spacer						
Finger harrow (400x10mm)	○				○				○				○				○				○				
Clod board	-				-				○				-				-				○				
Roller offering	Cage roller (ø 550mm), Double Cage roller (ø 400mm) - not on trailed versions, Actiring (ø 540mm), Actiflex (ø 580mm), Actipack (ø 560mm), Actipress Twin (ø 560mm) - not on trailed, 4m rigid and 6m fold versions																								
Transport wheels	-				-				400/60x15.5, 480/45x17 or 520/50x17				○				○				400/60x15.5, 480/45x17 or 520/50x17				
Gauge wheels	-				-				2x340/55x16				-				-				2x340/55x16				
Double suspension device	-				-				●				-				-				●				
Frame box section	100x100x8				100x100x8 and 200x200x10 (central frame)				100x100x8 and 300x200x10				100x100x8				100x100x8 and 200x200x10				100x100x8 and 300x200x10 (central frame)				
No. of double acting valves	1 or 0				2 or 1				4 or 3				1 or 0				2 or 1				4 or 3				
Brake	-				-				hydr. or pneumatic				-				-				hydraulic or pneumatic				
Integrated seeder a-drill 200/500	○				○				○				○				○				○				
Total weight with Cage roller (kg)*	1109	1274	1434	1695	1891	2365	2777	3215	3460	3882	4286	1509	1720	1937	2197	2766	3226	3782	3908	4376	4960	5421			
Total weight with Actiflex (kg)*	1242	1448	1649	1950	2268	2631	3125	3645	3726	4230	4716	1683	1935	2192	2574	3032	3574	4212	4174	4724	5390	5931			
Total weight with Actipack (kg)*	1349	1570	1785	2100	2419	2845	3369	3917	3940	4474	4988	1805	2071	2342	2725	3246	3818	4484	4388	4968	5662	6231			
Min. HP	50	55	70	90	110	110	130	150	130	150	170	70	90	110	130	150	170	190	150	170	190	210			
Max. HP	100	120	150	180	200	200	250	300	220	260	300	180	200	220	240	250	300	350	250	300	350	400			

\* Weights rigid machines calculated with hydraulic depth adjustment and lighting equipment; trailed models calculated with finger harrow, hydraulic depth adjustment, lighting equipment and front gauge wheels.  
 \*\* Pivoting eye, Fixe eye and drawbar extension not allowed in Germany; Fix eye not allowed in France

## QUALIDISC FARMER

mounted rigid



2.00m - 2.50m - 3.00m - 3.50m - 4.00m

mounted fold



4.00m - 5.00m - 6.00m

trailed



4.00m - 5.00m - 6.00m

## QUALIDISC PRO



2.50m - 3.00m - 3.50m - 4.00m



4.00m - 5.00m - 6.00m



4.00m - 5.00m - 6.00m - 7.00m

Information provided in this brochure is made for general information purposes only and for worldwide circulation. Inaccuracies, errors or omissions may occur and the information may thus not constitute basis for any legal claim against Kverneland Group. Availability of models, specifications and optional equipment may differ from country to country. Please consult your local dealer. Kverneland Group reserves the right at any time to make changes to the design or specifications shown or described, to add or remove features, without any notice or obligations. Safety devices may have been removed from the machines for illustration purposes only, in order to better present functions of the machines. To avoid risk of injury, safety devices must never be removed. If removal of safety devices is necessary, e.g. for maintenance purposes, please contact proper assistance or supervision of a technical assistant. © Kverneland Group Les Landes Génusson S.A.S.

**WHEN FARMING MEANS BUSINESS**

[kverneland.com](http://kverneland.com)